

# SR PACKAGING

*Reduce. Refill. Recycle.*  
*Sustainable skincare*  
*using EBM AIRLESS*  
*made of PCR.*



## Brand Partners

Shiseido, Laura Mercier, Kao, KOSÉ, bareMinerals, Victoria's Secret, NARS, REVLON, the list of brands partnering with SR Packaging is long and continues to grow.



## One place for innovations and aesthetics

Brands that offer unlimited skincare and beauty solutions for the consumer world are always hungry for innovations and aesthetic designs.

They entrust SR Packaging for new projects, working from concept, packaging application, tooling, decoration to manufacturing, use packaging to protect the delicate formulae and as a medium to maximize brand value and secure customer loyalty.

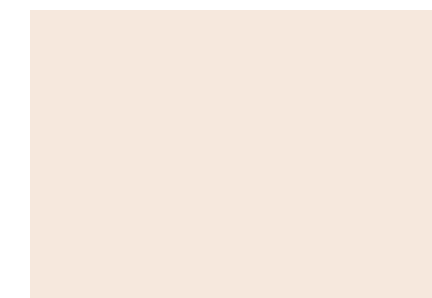
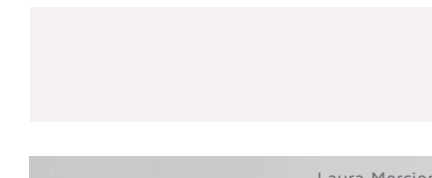
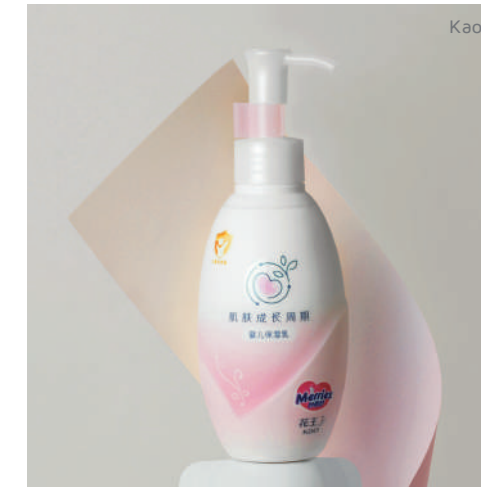
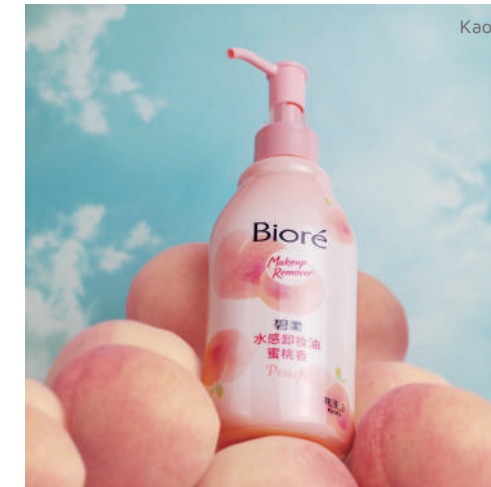

# Brand Partners

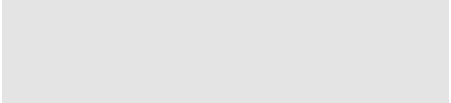
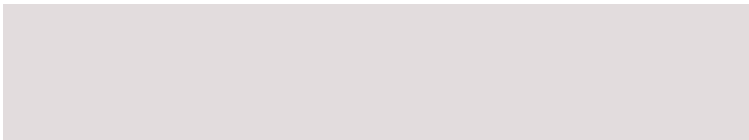

# Decoration Special Treatment



## Plastic Colorants

Enables the molded-in color during the molding process.

Apply to     



## Spray Coating

Adds a thin layer of glittery sheer, metallic glow, or a UV cured protection on the surface of a component.

Apply to     



## Flexo-Printing

Creates high-resolution, poster-quality imagery design with perfect finish.

Apply to 



## Offset Printing

Uses plates to transfer ink up to 8 colors, including half-tone and gradation, of artwork requiring precision.

Apply to 

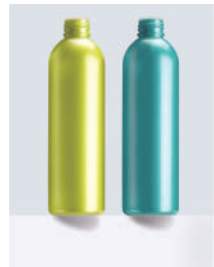

## Metalsheen

Allows any PET package to evince metallic luster.

Apply to   



## Metallization

Gives a plastic part a shiny, faux-metal finish, with the ability to add more decorations.

Apply to     



## Fabric Touch

Mimics the natural fabric texture and adds a warm touch to the tube surface.

Apply to 



## Silk Screen Printing





Decorates surface with texts or images of thick, bold, and glossy finish.

Apply to    



## Gradients

Gradient, Translucent Gradient, and Vac Met Gradient are achievable with adjustable opacity and translucency.

Gradient Apply to    

Vac Met Gradient Apply to   



## Soft Touch

Gives sensational feedback on the fingertips, a matte, frost, tactile touch.

Apply to   



## Brushed Metal

Creates a superior, warm and metallic shear for aluminum components in customizable color.

Apply to    



## Mold Texturing

Allows for intricate and consistent designs to be added to injection molds for decorative purposes.



## Hot Stamping

Enriches a brand image with solid, metallic colors.

Apply to      



## Patterned Metalization

Creates a unique pattern by adding over-coatings and UV processing to the known metallization process.

Apply to     

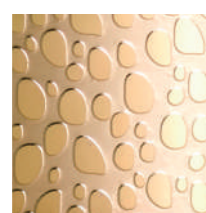

## Double Coat Anodizing

Achieves the design with the 3-step process: Anodizing - Silk Screen Print - Anodizing.

Apply to    



## Labeling

Enables multiple color decoration to flat surface or cylindrical component.

Apply to    



## Marbling Injection

Adds a unique identity for each component, offers aesthetically natural patterns without repetition.

Apply to   



Base Shape / Volume → 65 ml

Configurable components

65 ml 65 ml 30 ml 50 ml 100 ml 50 ml 60 ml 75 ml 30 ml

► Dispensers:  
SRP-A020-24C1FS  
SRP-A020-24C1FL1

**AIRLESS PUMP (External Spring)**  
Neck Size 20 Dosage:0.2ml

SRA-BCA-065-B Alpine  
SRA-BCC-065-B Ample  
SRA-BCE-030-B1 Maru Series  
SRA-BCE-050 Maru Series  
SRA-BCE-100 Maru Series  
SRA-BPA-050-B Diamond  
SRA-BPB-060-B Polygon  
SRA-BSA-075-B Kaku  
SRA-BOB-030-B Tottle

SRP-A020-20C21FL1 O.D.: 24  
SRP-A020-20C21FS O.D.: 26 (Cover)

Airless Pump (External Spring)

**AIRLESS PUMP Neck Size 24**

Dosage:1.0ml Dosage:1.0ml Dosage:1.0ml Dosage:1.0ml Dosage:0.7ml Dosage:0.5ml Dosage:0.2ml Dosage:0.2ml

SRP-A100-24C5F1 O.D.: 28  
SRP-A100-24C2F1 O.D.: 28  
SRP-A100-24C5F2 O.D.: 28  
SRP-A100-24C2F2 O.D.: 28  
SRP-A070-24C85F31 O.D.: 29  
SRP-A050-24C1F21 O.D.: 28  
SRP-A020-24C1FS O.D.: 28  
SRP-A020-24C1FL1 O.D.: 28

► Dispensers:  
SRP-A020-24C1FS  
SRP-A020-24C1FL1

► Dispensers:  
SRP-A020-24C1FS  
SRP-A020-24C1FL1

► Dispensers:  
SRP-A020-24C1FS  
SRP-A020-24C1FL1  
Only Overcap

SRA-BCF-170-B Burly  
SRA-BCB-180-B Vesta  
SRA-BCB-120-B Pallas  
SRA-BCD-180-B Aura  
SRA-BCD-120-B Aylin  
SRA-BSB-180-B Sif  
SRA-BCF-180-B Burly  
SRA-BCB-500-B Grande

	Ref.	OFC (ml)	H. (mm)	L. / W. (mm)	Neck size	Wt
Alpine	SRA-BCA-065-B	73	110	Φ32.7	20	11g
Ample	SRA-BCC-065-B	75	99.3	Φ35.2	20	9.7g
Maru Series	SRA-BCE-030-B1	36.7	75.5	Φ29	20	9g
	SRA-BCE-050	54	106	Φ29	20	12.5g
	SRA-BCE-100	105.5	105	Φ41	24	19g
Diamond	SRA-BPA-050-B	54.5	83	30.5x30.5	20	11g
Polygon	SRA-BPB-060-B	62.7	94.74	Φ33.54	20	12.5g
Kaku	SRA-BSA-075-B	82	89.9	34.2x34.2	20	11.6g
Tottle	SRA-BOB-030-B	35	121 (Cap)	36.9x20.8	Special thread	8.5g

	Ref.	OFC (ml)	H. (mm)	L. / W. (mm)	Neck size	Wt
Burly	SRA-BCF-170-B	186.3	124.7	Φ50.8	24/410	22.5g
Vesta	SRA-BCB-180-B	194	125	Φ50	24/410	22.5g
Pallas	SRA-BCB-120-B	138.4	92.5	Φ50	24/410	16.1g
Aura	SRA-BCD-180-B	195	129	Φ50	24/410	21.6g
Aylin	SRA-BCD-120-B	137.8	96.5	Φ50	24/410	17.3g
Sif	SRA-BSB-180-B	195	158	41x41	24/410	23.5g
Burly	SRA-BCF-180-B	187	126	Φ50.8	24/410	23g
Grande	SRA-BCB-500-B	524	183.15	Φ66	32/400	40g

EBM (extrusion blow molding) Airless material options

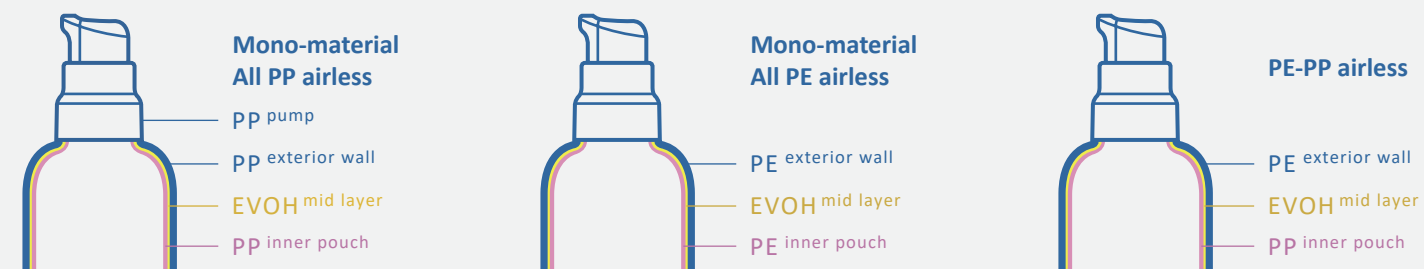

PCR Airless ► opt for PCR PE & PCR PP for material option.

Protect Marine Life ► opt for recycled PE made of post-use fish nets and fishing gear.



**SRA-ACB-050-Z**  
Use the opener to refill SRA-ASA & SRA-ACB Refillable Airless Bottles.

□ 15-50 ml	○ 15-50 ml	○ 15-50 ml	○ 15 ml	○ 30 ml	○ 50 ml	○ 70-150 ml	○ 70 ml	○ 105 ml	○ 150 ml
► Case : PMMA	► Case : SAN	► Case : PMMA				► Cap / Pump : PP Case : SAN			
<b>SRA-ASA</b> Series	<b>SRA-ACB</b> Series	<b>SRA-ACF</b> Series	<b>SRA-ACB-050-B1</b> SRA-ACB Series	<b>SRA-ACB-030-B</b> SRA-ACB Series	<b>SRA-ACB-050-B</b> SRA-ACB Series	<b>SRA-ACA</b> Series	<b>SRA-ACA-070-B</b> SRA-ACA-B Series	<b>SRA-ACA-105-B</b> SRA-ACA-B Series	<b>SRA-ACA-150-B2</b> SRA-ACA-B Series
			► Match Bottle SRA-ASA-015 SRA-ACB-015 SRA-ACF-015	► Match Bottle SRA-ASA-030 SRA-ACB-030 SRA-ACF-030	► Match Bottle SRA-ASA-050 SRA-ACB-050 SRA-ACF-050		► Match Bottle SRA-ACA-070	► Match Bottle SRA-ACA-105	► Match Bottle SRA-ACA-150-2

**| Airless Shuttle**

○ 50 ml	○ 50 ml	○ 60 ml	○ 60 ml	○ 60 ml	◇ 20 ml	◇ 20 ml	○ 60 ml	△ 15 ml	○ 60 ml	◐ 30 ml
► Cap / Pump / Collar : PP Case : PET		► Pump : PP Case : PET			► Cap : PETG Collar : PP Case : PMMA		► Cap : PETG Collar : PP Case : PMMA			► Cap / Case : PET Collar : ABS
<b>SRA-ACC-050</b> RePod	<b>SRA-ACC-050-B</b> RePod Cartridge	<b>SRA-ACD-060</b> Amari	<b>SRA-ACD-060-B</b> Amari Cartridge	<b>SRA-CCA-060</b> Airless Shuttle	<b>SRA-CTA-020-1</b> Cartridge (½) + sprayer	<b>SRA-CTA-020</b> Cartridge (½) + pump	<b>SRA-CCB-060</b> Airless Shuttle 4S	<b>SRA-CTA-015</b> Cartridge (¼) + pump	<b>SRA-CCC-060</b> le DUO	<b>SRA-CIA-030</b> Cartridge (½) + pump
					► Match Bottle - SRA-CCA-060			► Match Bottle SRA-CCB-060		► Match Bottle SRA-CCC-060

	Ref.	OFC (ml)	H. (mm)	L. / W. (mm)	Dosage (ml)	Wt
SRA-ASA Series	SRA-ASA-015	/	100	38x38	0.23	93.1g (All)
	SRA-ASA-030	/	129.7	38x38	0.23	117.2g (All)
	SRA-ASA-050	/	149.7	38x38	0.23	134.2g (All)
SRA-ACB Series	SRA-ACB-015	/	100.1	Φ39.9	0.23	67.1g (All)
	SRA-ACB-030	/	130	Φ39.9	0.23	89.1g (All)
	SRA-ACB-050	/	147	Φ39.9	0.23	93.6g (All)
SRA-ACF Series	SRA-ACF-015	/	101.2	Φ43.5	0.23	58.8g (All)
	SRA-ACF-030	/	130	Φ48.5	0.23	85.9g (All)
	SRA-ACF-050	/	154	Φ48.5	0.23	94g (All)
SRA-ACB Series	SRA-ACB-015-B1	21.7	60	Φ27	/	5.7g
	SRA-ACB-030-B	35.9	89	Φ27	/	7.9g
	SRA-ACB-050-B	55.3	113	Φ29	/	10.5g
SRA-ACA Series	SRA-ACA-070	/	118.8 (Cap)	Φ48.6	1.0	80.2 (All)
	SRA-ACA-105	/	145.8 (Cap)	Φ48.6	1.0	95.8 (All)
	SRA-ACA-150-2	/	183.1 (Cap)	Φ48.6	1.0	116.6 (All)
SRA-ACA-B Series	SRA-ACA-070-B	81	79.9	Φ41.5	/	12.2g
	SRA-ACA-105-B	114	106.9	Φ41.5	/	15.5g
	SRA-ACA-150-B2	159	143.26	Φ41.5	/	21.3g

	Ref.	OFC (ml)	H. (mm)	L. / W. (mm)	Dosage (ml)	Wt
RePod	SRA-ACC-050	/	84 (Cap)	Φ68	0.2	112.2g (All)
	SRA-ACC-050-B	57.3	46.5	Φ51	/	10.2
Amari	SRA-ACD-060	/	110 (Pump)	Φ50	0.2	71.4g (All)
	SRA-ACD-060-B	71	75.5	Φ39.5	/	10.7
Airless Shuttle	SRA-CCA-060	/	116.2 (Cap)	Φ55.92	/	125.8g (All)
	SRA-CTA-020-1	23.5	106.2	37.52	0.2	15.1g
Airless Shuttle 4S	SRA-CTA-020	23.5	106.2	37.52	0.2	15.1g
	SRA-CCB-060	/	116.2 (Cap)	Φ55.92	/	123.4g (All)
le DUO	SRA-CTA-015	18	106.09	29.91	0.2	11.1g
	SRA-CCC-060	/	110 (Cap)	Φ50.09	/	84.2g (All)
	SRA-CIA-030	34	104.79	45.49	0.2	17.4g

**Economic Benefits of EBM Airless**

- ★ Same OFC as dip-tube bottles.
- ★ Works with all viscosity types.
- ★ Fills like an atmospheric pump.
- ★ Launch initiatives with problematic formulas.



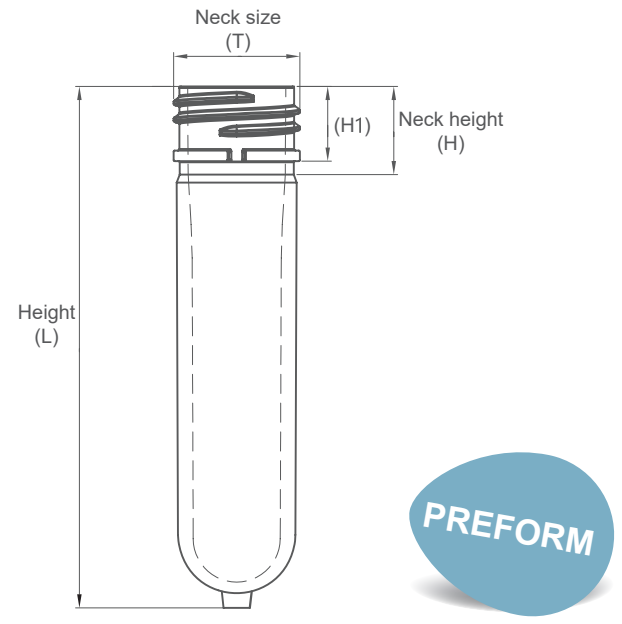

SPEC	Neck size (T)mm	Neck height (H)mm - (H1)mm	Length (L)mm	OFC (V)ml
SRM-R24410-19-093 / 19g	24	410-14	93	100-180
SRM-R24410-25-104 / 25g	24	410-14	104	150-250
SRM-R24410-33-120 / 33g	24	410-14	120	250-400
SRM-R28410-35-108 / 35g	28	410-14.3	108	350-650
Φ18-5g	18	410-13	43	10-25
Φ18-7.8g	18	410-13	61	25-40
Φ18-11g	18	410-13	67	50-90
Φ18-14g	18	410-14.5	90	80-150
Φ20-12g	20	410-12	75	60-90
Φ20-18.5g	20	400/410-10.5/12	92	90-180
Φ20-24g(4)	20	410-12.5	118	150-240
Φ22-26g	22	410-11.5	110	150-250
Φ22-42g	22	410-11.3	126	300-500
Φ24-10g	24	410-14.5	60	50-90
Φ24-16g(4)	24	410-14	70	90-150
Φ24-18g	24	410/RVS Nozzel Head-14.83/12.85	90	100-180
2SRΦ24-20g	24	400Nozzel Head/410-12/14	95	100-200
Φ24-23g	24	410-13.8	83	100-240
2SRΦ24-25g	24	400/410-12/14	118	150-250
Φ24-30g	24	400/410-12/14	116	250-350
Φ24-35g	24	400/410-12/14	130	250-400
Φ24-39g	24	410-12.45	134	300-450
Φ24-42g	24	410/415-14	145	300-500
Φ28-30g	28	400/410-14.5	100	350-600
Φ28-36g	28	410-16.1	108	350-650
Φ28-43g	28	410-16.7	130	400-700
Φ33-18g(4)	33	400-14.5	58	90-150
Φ33-20g(4)	33	400-14.5	65	120-180
Φ33-28g	33	400-18	105	180-350
Φ33-38g	33	400-18	130	300-500
Φ33-54g	33	400-12.5	146	500-1000
Φ38-31.5g	38	400-10.4	100	250-400
Φ40-28g	40	Foam Pump/410-11.75	83	150-350
Φ43-23g	43	Foam Pump-17.2	75	150-350
Φ43-28g	43	Foam Pump-17.5	85.5	150-350
Φ48-14g	48	400(G.F)-9	30.5	50-100
Φ50-16g	50	400(G)-10.2	30.5	50-100
Φ65-40g	65	400-13.5	90	300-500
Φ65-45g	65	400-13.5	90	300-500
Φ67.5-22g	67.5	400(G.F)-11.6	41.5	100-250
Φ70-21g	70	400(G.F)-9.65	35	100-250

SPEC	Neck size (T)mm	Neck height (H)mm - (H1)mm	Length (L)mm	OFC (V)ml
Φ90-27g	90	400(G.F)-11.75	33.5	100-250
Φ90-30g	90	400(G.F)-11.75	45	200-400
Φ90-66g	90	400-19.8	90	1000-1500
Φ106-58g	106	400(G.F)-15	70	500-1000
KSDΦ76-46g	76	16.1	44.5	150-200
KSDΦ93-72g	93	17.5	70.5	300-500
KJΦ73-46g	73	17.3	54	100-300
KJΦ93-65g	93	17.3	72	350-600

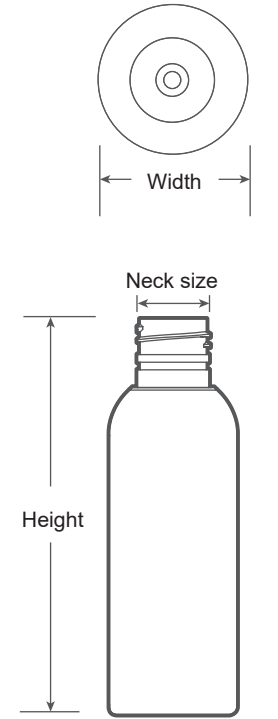

Base Shape / Volume → 60 ml MIT Made in Taiwan



SRB-A060B-14g SRB-AF020B SRB-AF100B-1 SRB-AF200B-2 SRB-AF-B Series SRB-AFH-B Series SRB-AFR150B



SRB-AFR-B Series SRB-AR200B SRB-AR-B Series SRB-ASB020B SRB-ASB030B SRB-AT-B Series SRB-AW050B



SRB-BT-B Series SRB-H150B-2 SRB-Y030B SRB-YF150B

Ref.	OFC (ml)	H. (mm)	L. / W. (mm)	Neck size	Wt
SRB-A060B-14g	70	91.5	Φ36.1	24/410	14g
SRB-AF020B	34	75	Φ27.5	20/410	6g
SRB-AF100B-1	108.5	100.05	Φ42.3	24/410	19g
SRB-AF200B-2	231	143	Φ50	24/410	27g
SRB-AF-B Series	SRB-AF060-B MIT 64	87.9	Φ34.9	20/410	11g
	SRB-AF120B-B MIT 137.5	120.6	Φ43	24/410	22g
	SRB-AF120B-2 140	120.6	Φ43	24/410	19g
SRB-AFH-B Series	SRB-AFH030B 36.5	73.03	Φ30.23	20/410	9g
	SRB-AFH120B 128.1	134.24	Φ39.37	20/410	18.5g
SRB-AFR150B	174.3	120	Φ50.3	24/410	22g
SRB-AFR-B Series	SRB-AFR080B 94.6	97	Φ41	20/410	11g
	SRB-AFR120B 137	114	Φ47	20/410	19g
	SRB-AFR250B 277	138.7	Φ58	24/410	25g
SRB-AR200B	212	139.5	Φ49	24/410	25g

Ref.	OFC (ml)	H. (mm)	L. / W. (mm)	Neck size	Wt
SRB-AR-B Series	SRB-AR100B 106.5	105	Φ41	20/410	15g
	SRB-AR150B 160.5	121.1	Φ46	24/410	19g
	SRB-AR300B 326	154	Φ58	24/410	33g
SRB-ASB020B	24.5	61.3	Φ28.3	18/410	8g
SRB-ASB030B	35.7	78.2	Φ28.3	18/410	10g
SRB-AT-B Series	SRB-AT120B 136	121	Φ43	Special thread	25g
	SRB-AT180B 201	144.5	Φ47	Special thread	32g
SRB-AW050B	70	68.9	Φ42.3	24/410	10g
SRB-BT-B Series	SRB-BT120B 136	115	40x40	Special thread	25g
	SRB-BT180B 201	138.5	44x44	Special thread	32g
SRB-H150B-2	170.4	125.5	Φ47.2	24/410	32g
SRB-Y030B	37	75.5(Cap)	Φ32.2	18/410	8g
SRB-YF150B	172.2	140.2	Φ47.4	24/410	32g



DSCE Series    DSA/SRB Series    DSB Series    DSS/S Series    SAC-BB Series    SAD-B Series    SA-FH/SRB Series



SAC/SRB Series    SA-F/SRB Series    SAL Series    SA/SRB Series    S-A Series    SBC/SRB Series    SB-C Series



SB Series    S-B Series    SDB Series    SD Series    SE Series    SF Series    SG Series



SI Series    SJ Series    SK Series    SL Series    SM/DSS Series    SN Series    SP/SRB Series

Ref.	OFC (ml)	H. (mm)	L. / W. (mm)	Neck size	Wt
<b>DSCE Series</b>					
DSCE-050B	60	85	35.3x35.3	24/410	10g
DSCE-150B	164	132.4	45.2x45.2	24/410	20g
DSCE-200B	204	165	45x45	24/410	25g
DSCE-275B	279	155	54x54	24/410	30g
<b>DSA / SRB Series</b>					
DSA-020	24	68	Φ24.5	18/410	5g
DSA-030	35	77	Φ28	18/410	7.8g
DSA-040	46	80.5	Φ31	18/410	7.8g
SRB-A050-B	57	90	Φ32.5	18/410	11g
DSA-050	57	90	Φ32.5	18/410	11g
SRB-AF100B	116	116	Φ40.1	24/410	19g
DSA100	114	116	Φ40	24/410	20g
DSA125	140	121	Φ43	24/410	20g
DSA150	170	136	Φ44	24/410	20g
SRB-AF200B	221	154	Φ47	24/410	25g
DSA200	221	154	Φ47	24/410	25g
SRB-A250-B	273	159	Φ51	24/410	25g
SRB-AF250B	273	159	Φ51	24/410	25g
DSA250	270	159	Φ51	24/410	30g
DSA280	278	160.5	Φ51	24/410	25g
<b>DSB Series</b>					
DSB050	56	85.3	30.5x30.5	20/410	12g
DSB100	107	121.8	34x34	20/410	18.5g
DSB150	160	133.8	39x39	20/410	18.5g
DSB200	210	151	42x42	24/410	25g
DSB210	215	153	42x42	24/410	25g
DSB250	263	163.5	45x45	24/410	30g
<b>DSS / S Series</b>					
DSS-262A	271	105.3	Φ66.5	24/410	23g
S20080A	112	83	Φ48.8	20/410	12g
<b>SAC-BB Series</b>					
SAC-050BB	61	93.6	Φ33	20/410	12g
SAC-080BB-12g	86	122.7	Φ33	20/410	12g
SAC-080BB-18.5g	81	122.7	Φ33	20/410	18.5g
<b>SAD-B Series</b>					
SAD100-B	110	125.5	Φ41	24/410	20g
SAD120-B	130	139.6	Φ41	24/410	20g
<b>SA-FH / SRB Series</b>					
SA-FH150	165	102	Φ53.1	24/410	20g
SA-FH200	220	112	Φ58.3	24/410	23g
SRB-AFH250-B	278.6	136.4	Φ58	24/410	25g
SRB-AFH250B	278.6	136.4	Φ58	24/410	25g
SA-FH250	270	122	Φ61.8	24/410	30g
SA-FH300	322	131.5	Φ64.3	24/410	30g
<b>SAC / SRB Series</b>					
SAC090	105	80.5	Φ47.5	24/410	10g
SAC120	135	102.8	Φ47.5	24/410	20g
SAC150	165	120.2	Φ47.5	24/410	20g
SAC180	195	138.9	Φ47.5	24/410	25g
SAC200	231	158.9	Φ47.5	24/410	30g
SAC210	225.5	156.8	Φ47	24/410	25g
SAC250	265	181.5	Φ47	24/410	30g
SAC300	316	213	Φ47	24/410	35g
SAC090-B	95	97	Φ41	20/410	18.5g
SRB-AC100B	113	107.6	Φ41.5	20/410	18g
SAC100-B	110	109.5	Φ41	24/410	20g
SRB-AC120B	135	128.5	Φ41	24/410	19g
SAC120-B	135	128.5	Φ41	24/410	20g
SAC150-B	160	150	Φ41	24/410	25g
<b>SA-F / SRB Series</b>					
SA-F080	91	80.5	Φ43.4	20/410	12g
SA-F120	134	90.5	Φ49.5	24/410	16g
SA-F150	164	100.5	Φ51.5	24/410	20g
SA-F200	219	110.5	Φ56.2	24/410	23g
SRB-AF250B-2	267	120.5	Φ59.5	24/410	29g
SA-F250	269	120.5	Φ59.4	24/410	30g
SRB-AF300B	324	132	Φ62	24/410	33g
SA-F300	322	130.5	Φ61.8	24/410	30g
SRB-AF500B	540	173.85	Φ67.8	24/410	35g
SA-F500	524	173.9	Φ67	24/410	39g
<b>SAL Series</b>					
SAL090	94	87.5	Φ47.3	24/410	16g
SAL120	134	112	Φ47.2	24/410	20g
SAL150	154	120.5	Φ47.2	24/410	20g
SAL180	191	145.5	Φ47.2	24/410	25g
SAL200	213	153.5	Φ47.2	24/410	25g
<b>SA / SRB Series</b>					
SA010 (ASB)	14	59.1	Φ21	18/415	5g
SA010-H14.2	14	59	Φ21	18/410	5g
SA030	37	71.3	Φ30	18/415	7.8g
SA050	53.5	82.5	Φ33	18/415	7.8g
SA060	70	102	Φ33	20/410	12g
SRB-A080B	92	98	Φ40	24/410	19g
SA085	89	98	Φ40	24/410	23g
SA100-415	108	118.5	Φ39.6	24/415	20g

Ref.	OFC (ml)	H. (mm)	L. / W. (mm)	Neck size	Wt
<b>SA / SRB Series</b>					
SA120	132	128.1	Φ40.3	24/410	20g
SRP SA125	142	138.5	Φ40	24/410	20g
SA180-410	202	152.8	Φ45	24/410	25g
SA180-415	204	161	Φ45	24/415	25g
SA200	218	145.8	Φ48.1	24/410	25g
SA200-415	221	154	Φ48.1	24/415	25g
SA240	257	181.9	Φ46.2	24/410	30g
SA420	425	195.3	Φ57	24/410	30g
SA28500	507	222.2	Φ57.9	28/410	43g
<b>S-A Series</b>					
S-030A	33	73.5	Φ30.4	18/410	7.8g
S-110A	116	115.6	Φ43.6	24/410	20g
S-157A	158	130.3	Φ47.8	24/410	25g
<b>SBC / SRB Series</b>					
SRB-BC120B	132	110.5	40x40	24/410	19g
SBC-120	132	110.5	40x40	24/410	20g
SBC-150	162	132	40x40	24/410	25g
<b>SB-C Series</b>					
SB-C050	55	90	34x28	18/410	11g
SB-C100	105	100.5	39x39	24/410	23g
SB-C120	130	117.5	39x39	24/410	23g
SB-C150	156	140	39x39	24/410	23g
SB-C200	211	152	43x43	24/410	35g
<b>SB Series</b>					
SB060	67	79	34.5x34.5	20/410	12g
SB120	127.5	102.1	41x41	20/410	18.5g
SB180	200	128.9	45x45	24/410	25g
SB240-410	265	150.3	47.6x47.6	24/410	30g
SB240-415	273	158.4	47.6x47.6	24/415	30g
<b>S-B Series</b>					
S-B3030	46	59.5	Φ35.8	30/400	12g
S-B3050	68	82.5	Φ35.8	30/400	13g
S-B3080	95	117	Φ35.8	30/400	23g
<b>SDB Series</b>					
SDB020	24	57.5	26x26	18/410	5g
SDB030	34.5	67.4	29x29	18/410	7.8g
SDB040	46	71.2	32x32	18/410	7.8g
SDB050	58	85.5	32x32	18/410	11g
<b>SD Series</b>					
SD060	66	87.5	Φ45.2	20/410	12g
SD120	133	114.5	Φ56	24/410	20g
SD180	196	136.5	Φ63.6	24/410	25g
SD240	260	145.5	Φ71.4	24/410	25g
<b>SE Series</b>					
SE150	156	141	Φ43	24/410	20g
SE210	216	164	Φ46	24/410	25g
<b>SF Series</b>					
SF100	108	131.5	49x31	20/415	18.5g
SF250-410	270	169.2	67x41.5	24/410	30g
SF250-415	272	176.7	67x41.5	24/415	30g
SF350	360	192.8	72x47	24/415	35g
SF550	565	207.5	83x52	33/400	54g
<b>SG Series</b>					
SG250	258	178.6	72x60	24/415	28g
SG400	410	216	78x66	24/415	36g
<b>SI Series</b>					
SI150	147	139.2	Φ44	20/410	18.5g
SI250	245	175.7	Φ50.4	24/410	25g
<b>SJ Series</b>					
SJ210	224	124	Φ55	33/400	28g
SJ310	323	144	Φ61	33/400	28g
SJ455	462	155.9	Φ70.6	24/410	36g
SJ510	523	140.5	Φ80.5	33/400	38g
SI800	808	182	Φ83.8	28/410	43g
<b>SK Series</b>					
SK250	256	147	65x49	24/415	28g
SK400	410	167	74x56	24/415	36g
<b>SL Series</b>					
SL220	228	154	65.4x38.3	24/415	30g
SL420	424	183.9	80.4x47.3	24/415	36g
SL720	728	174.5	101.6x62.8	33/400	54g
<b>SM / DSS Series</b>					
SM250	253	148	Φ58.2	24/410	28g
SM400	410	180	Φ62.2	24/410	36g
DSS-250A	263	128	Φ64	28/410	36g
DSS-350A	363	159	Φ64	28/410	36g
<b>SN Series</b>					
SN250	256	146.5	67.6x48	24/415	28g
SN400	410	166.5	80x54	24/415	36g
SN780	785	193	93.6x68	33/400	54g
SN1030	1049	209.5	105x74.3	33/400	54g
<b>SP / SRB Series</b>					
SP100	114	101.3	Φ43.2	24/410	16g
SP150	165	121.5	Φ47	24/410	20g
SRB-AFR230B	258	138	Φ55	24/410	25g
SP240	256	138	Φ55	24/410	25g
SP300	306	147	Φ57.5	24/410	25g
SP360	369	149.5	Φ63	24/410	30g
SRB-AFR500-B2	525	168.8	Φ70.2	24/410	35g
SRB-AFR500B	525	168.8	Φ70.2	24/410	33g
SP500	525	168.8	Φ70.2	24/410	33g



SH-B Series, SH-F Series, SHH Series, SH-R/SHR/SH-SR Series, SH/SRB Series, SQ Series, SRB Series

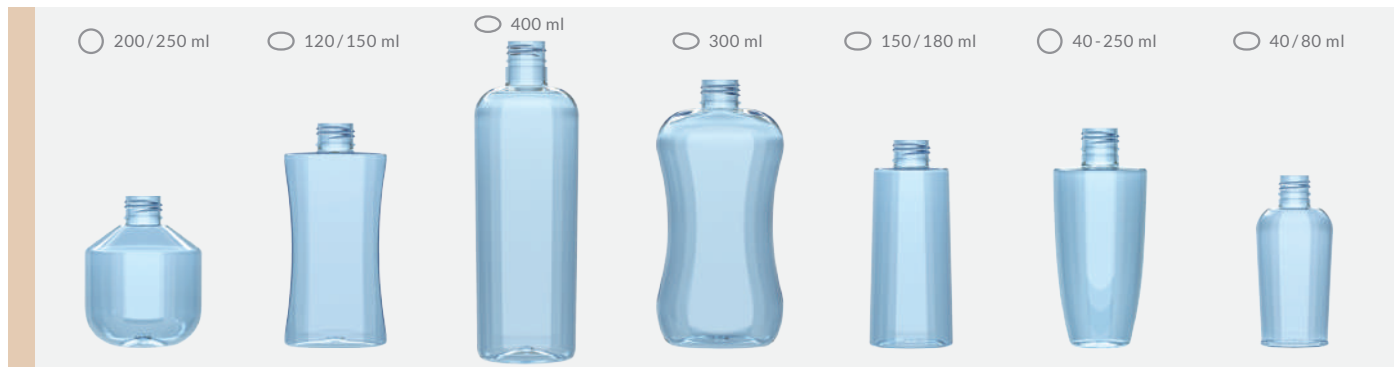

SWA Series, SXA Series, SX28400, SX24300, SYA Series, SYB-C/SYC Series, SYB Series



SYF Series, SYG Series, SYH Series, S NO.1 Series, S NO.2 Series, S NO.3 Series, S NO.4 Series



S NO.5 Series, S NO.6 Series, S018050A, S020125A, S20050A, S20090-1, S20095

	Ref.	OFC (ml)	H. (mm)	L. / W. (mm)	Neck size	Wt
SH-B Series	SH-350B	375	136.8	Φ68.7	28/410	30g
	SH-500B	580	193.3	Φ68.7	28/410	36g
SH-F Series	SH-F080	89	78.4	Φ44.2	20/410	12g
	SH-F120	132	88.4	Φ50.6	24/410	16g
	SH-F150	162	98.4	Φ52.6	24/410	20g
	SH-F200	217	108.4	Φ57.5	24/410	23g
	SH-F250	267	121.4	Φ59.6	24/410	25g
	SH-F300	319	131.4	Φ62.4	24/410	30g
	SHH Series	SHH-120	138	125	Φ43	20/410
SHH-150		169	154	Φ43	24/410	36g
SHH-200		220	170	Φ46.5	24/410	45g
SH-R / SHR / SH-SR Series	SH-R020	26	61.3	Φ28.3	18/410	7.8g
	SH-R035	34.5	78.2	Φ28.3	18/410	11g
	SH-R050	59	90	Φ33.2	20/410	12g
	SH-R080	89	100	Φ37.8	20/410	12g
	SH-R100	112	110	Φ40.6	24/410	16g
	SH-R120	132	120	Φ41.7	24/410	16g
	SH-R150	162	130	Φ44.2	24/410	20g
	SH-R200	217	146	Φ48	24/410	25g
	SH-R250	267	162	Φ50	24/410	25g
	SH-R300	319	178	Φ51.9	24/410	30g
	SHR-060	70	89.5	Φ35	20/410	12g
	SHR-085	100	123.8	Φ34.8	20/410	12g
	SHR-150	162	127.6	Φ44	24/410	20g
	SHR-250	258	148.5	Φ51.2	24/410	25g
	SH-SR030	36	81	Φ28.2	18/410	11g
	SRP SH035 (ASB)	35.5	78.2	Φ28.3	18/410	10g
	SH / SRB Series	SRB-ASB010B	13	52.7	Φ22.3	18/415
SH010 (ASB)		13	52.7	Φ22.3	18/410	5g
SH020 (ASB)		23	69.7	Φ24	18/410	5g
SH030		33	78.4	Φ27.5	18/410	7.8g
SH045		48	88.3	Φ30	18/410	7.8g
SH050		63	84	Φ35.5	24/410	10g
SH080		81	101.3	Φ36.5	20/410	12g
SH090		95	107.5	Φ38	24/410	10g
SH100		111	118	Φ39.5	20/410	18.5g
SH090-415		93	114	Φ38	24/415	18g
SH120-410		133	132.7	Φ40	24/410	20g
SH120-415		135	141.2	Φ40	24/415	20g
SH150		164	143.6	Φ42.6	24/410	20g
SRB-RH150B		189	153.5	Φ44.2	24/410	25g
SH180		188	153.5	Φ44.2	24/410	25g
SH200		210	153.6	Φ47	24/410	25g
SH250		274	163.6	Φ51.4	24/410	30g
SH280		275	171.8	Φ50.2	24/410	30g
SH300		310	175.1	Φ53.2	24/410	30g
SH400		410	196.2	Φ57.1	24/410	36g
SH500	506	212.4	Φ60	28/410	43g	
SQ Series	SQ150-410	168	176.5	Φ38	24/410	20g
	SQ150-415	165	184	Φ38	24/415	20g
	SQ300-410	418	219.5	Φ48.8	24/410	30g
	SQ300-415	415	227	Φ48.8	24/415	30g

	Ref.	OFC (ml)	H. (mm)	L. / W. (mm)	Neck size	Wt
SRB Series	SRB-150	168	128.5	43.2x43.2	24/410	25g
	SRB-400	425	172.5	60x60	28/410	43g
SWA Series	SWA-200	220	89	Φ70	24/410	23g
	SWA-250	270	102	Φ70	24/410	23g
SXA Series	SXA-120	122	119.5	56x29	20/410	12g
	SXA-150	154	131.5	60.5x31	24/410	20g
<b>SX28400</b>		<b>410</b>	<b>209.1</b>	<b>69x45.6</b>	<b>28/415</b>	<b>43g</b>
<b>SX24300</b>		<b>310</b>	<b>152.5</b>	<b>73.9x46.5</b>	<b>24/410</b>	<b>30g</b>
SYA Series	SYA-150	169	128.6	51x46	24/410	20g
	SYA-180	200	145.1	52.5x47	24/410	25g
SYB-C / SYC Series	SYC-040	43.5	78.2	Φ34	18/410	9g
	SYC-080	83	95.8	Φ41.7	20/410	12g
	SYB-200C	212	133	Φ56	24/415	20g
SYB Series	SYB-250C	256	156.3	Φ56	24/415	25g
	SYB-040	43.5	82.6	38x27	18/410	9g
SYF Series	SYF-080	86	94	70x27	20/410	12g
	SYF-150	163	113.4	88x33.2	24/410	16g
SYG Series	SYG-150	170	138.2	Φ50.8	24/410	16g
	SYG-200	220	162	Φ52.5	24/410	25g
SYH Series	SYH-080	80	81	52.5x42	24/410	10g
	SYH-150	150	103.8	62x52	24/410	20g
S NO.1 Series	S20135	138	135.5	60.5x35	20/410	18.5g
	S20165	154	135.5	60.7x35	20/410	18.5g
	S24150	172	144	61.2x38.4	24/410	20g
	S24230-1	236	165	65x42.4	24/410	25g
S NO.2 Series	S24500	529	147.5	Φ76.9	24/400	30g
	S28350	352	101	Φ80.1	28/400	30g
	S28500	510	112	Φ94.3	28/400	30g
S NO.3 Series	S28540	532	128	Φ88	28/400	30g
	S20060	66	91	45.9x26	20/410	12g
	S28600B	601	151	82.2x65	28/400	43g
S NO.4 Series	S33800B	830	193.5	82.2x66.5	33/400	56g
	S331000B	1092	212.5	90x73	33/400	56g
	S24250-1	255	161.8	69.4x41.1	24/410	30g
S NO.5 Series	S33750	758	182.8	96x71.5	33/400	54g
	S33800A	800	180.1	101.3x67.5	33/400	54g
	S33800-1	800	197.8	92.8x71.8	33/400	54g
	S331000A	1070	230	101.3x67.5	33/400	54g
S NO.6 Series	S20090-2	93	109.5	56x32	20/410	18.5g
	S20110	112	117	60x33.6	20/410	18.5g
	S24200	211	142	64.5x40	24/410	25g
S NO.6 Series	S33500	500	178.9	96.5x50.2	33/400	54g
	S020100	103	126.7	47x34	20/410	12g
S020150	153	140.5	54x40	20/410	18.5g	
<b>S018050A</b>		<b>61</b>	<b>121.1 (Cap)</b>	<b>36.5x31.5</b>	<b>18/410</b>	<b>9g</b>
<b>S020125A</b>		<b>140</b>	<b>128.9</b>	<b>52.6x32.6</b>	<b>20/415</b>	<b>18.5g</b>
<b>S20050A</b>		<b>58</b>	<b>95.3</b>	<b>42x26.6</b>	<b>20/410</b>	<b>12g</b>
<b>S20090-1</b>		<b>90</b>	<b>110.3</b>	<b>47.6x30</b>	<b>20/410</b>	<b>18.5g</b>
<b>S20095</b>		<b>102</b>	<b>111.4</b>	<b>45.9x38</b>	<b>20/410</b>	<b>18.5g</b>



S20100-1 S20100-2 S20120-1 S20120-2 S24100A S24120 S24165



S24230-2 S24250-2 S24300 S33600 S33800-2 S40500B S43100-28g

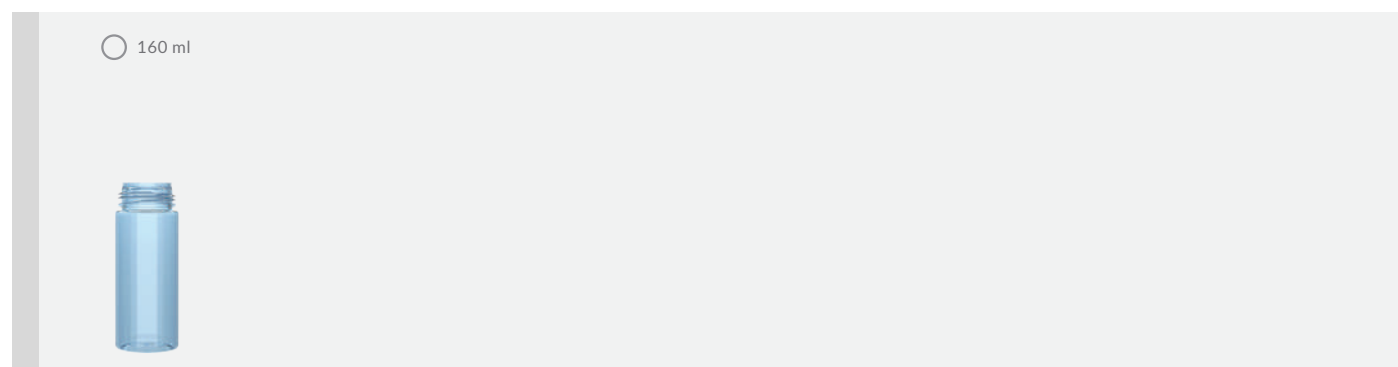

S43160A

Ref.	OFC (ml)	H. (mm)	L. / W. (mm)	Neck size	Wt
S20100-1	103	112.5	55.6x31.5	20/410	18.5g
S20100-2	103	107.8	Φ41	20/410	18.5g
S20120-1	132	122.3	54.4x35.2	20/410	18.5g
S20120-2	124	127	56x36	20/410	18.5g
S24100A	108	108	39.5x39.5	24/415	16g
S24120	125	113.5	54x31	24/400	20g
S24165	200	161.5	54.5x39.5	24/410	25g
S24230-2	236	166.5	60x33	24/410	25g

Ref.	OFC (ml)	H. (mm)	L. / W. (mm)	Neck size	Wt
S24250-2	263	127	Φ64	24/410	25g
S24300	306	196.5	Φ50	24/410	30g
S33600	600	151	96x72	33/400	54g
S33800-2	830	196.8	94.6x73	33/400	54g
S40500B	530	133.5	104x68	40/400	28g
S43100-28g	154	105.5	Φ48	43/400	28g
S43160A	190	125	Φ48	43/400	28g

**Heavy-Wall Series** Opt for CRR, chemically recycled resin, same clarity as virgin plastic.



H-A Series H-B Series H-120C H-070C GH Series SRJ-S066 Series SRJ-S077-100 Series SRJ-S045-030 Series

**PE Bottle**



SRB-A160A-B SRB-A250B-B SRB-EB150B SRB-EFH-B Series



SRB-EA250B SRB-EA150B SRB-EP-B Series

	Ref.	OFC (ml)	H. (mm)	L. / W. (mm)	Neck size	Wt
H-A Series	H-040A	45	90	Φ31	18/410	19g
	H-060A	70	100.5	Φ35.7	20/410	24g
	H-120A	142	142.8	Φ41	24/410	36g
	H-150A	173	151	Φ44	24/410	45g
H-B Series	H-040B	45.5	87.5	Φ34	18/410	19g
	SRB-H060C-B MIT	71	109	Φ36	20/410	24g
	H-060B	71	109	Φ36	20/410	24g
	H-120B	146	138.8	Φ44	24/410	36g
	SRB-H150C-B MIT	176	151.7	Φ46	24/410	45g
H-C Series	H-150B	175	151.7	Φ46	24/410	45g
	H-070C	84	89	Φ44	18/415	19g
	H-120C	135	123	Φ44	24/410	36g
GH Series	H-150C	166	147.8	Φ44	24/410	45g
	GH-08	9.3	27.5	Φ36.3	Φ32mm	17.5g
	GH-15	17.5	33	Φ42.3	Φ38mm	26.5g

	Ref.	OFC (ml)	H. (mm)	L. / W. (mm)	Neck size	Wt
GH Series	GH-30	35	37	Φ52.3	Φ48mm	38.5g
	GH-50	52.5	37	Φ61.4	Φ58mm	47.7g
SRJ-S066 Series	SRJ-S066-060	81	46.9(Cap)	Φ71.9	Φ66mm	95.2g
	SRJ-S066-100	114	59(Cap)	Φ71.9	Φ66mm	115.2g
	SRJ-S077-100	110	37.4(Cap)	Φ80.3	77/400	41.5g
	SRJ-S045-030	35	48.6(Cap)	Φ53.15	45/400	47.5g
	SRB-A160A-B MIT	186	124.5	Φ50.5	24/410	19g
	SRB-A250B-B MIT	266	139	Φ56	24/410	24g
	SRB-EB150B	150	132.7	40*40	24/410	27.5g
SRB-EFH-B Series	SRB-EFH050B	65	88.4	Φ35.8	24/410	10.5g
	SRB-EFH100B	115	110	Φ42	24/410	16.2g
	SRB-EA250B	265	160	Φ50.8	24/410	22g
	SRB-EA150B	166	132	Φ44.75	24/410	17g
SRB-EP-B Series	SRB-EP030B	35.5	64.7	Φ32	Special thread	5.6g
	SRB-EP060B	69	84.7	Φ38	Special thread	8.5g



**SCREW CAP**

Apply to:

24C-SA40 : DSA085 , DSA100 , DSA125  
24C-SA44 : DSA150 , DSA200

**SPEC**

Material	PP	
Neck Size	24/410	
Item No.	Height	Width
24C-SA40	33 mm	Φ40 mm
24C-SA44	45 mm	Φ47 mm

**Screw Cap**



SC-A-SR    SC-B-SR    SC-C-SR    SC-D-SR

▶ SC-A-SR	▶ SC-B-SR	▶ SC-C-SR	▶ SC-D-SR
Neck size	Neck size	Neck size	Neck size
24/410	20/410 24/410	24/410	24/410

**Disc Cap**



DC-A-WE    DC-B-WE    DC-C-WE    DC-D-WE

▶ DC-A-WE	▶ DC-B-WE	▶ DC-C-WE	▶ DC-D-WE
Neck size	Neck size	Neck size	Neck size
18/410 20/410 24/410 18/415 24/415 28/415	18/410 20/410 24/410	24/410 28/410 24/415 28/415	24/415

**Flip-Top Cap**



FT-A-WE    FT-B-WE    FT-C-WE

▶ FT-A-WE	▶ FT-B-WE	▶ FT-C-WE
Neck size	Neck size	Neck size
20/410 24/410 28/410 28/415	18/415 20/415 24/415 28/415	24/410

**SPRAYER 18/410** Dosage 0.15 ml 



• SRP-D015-18C1FS    SRP-D015-18C2FS    • SRP-D015-18C2FS2    • SRP-D015-18H1FS    • SRP-D015-18H2FS    • SRP-D015-18H3FS    • SRP-D015-18C3FS  
O.D.: 22    O.D.: 22    O.D.: 22    O.D.: 22    O.D.: 22    O.D.: 22    O.D.: 20

**SPRAYER 20/410** Dosage 0.18 ml



• SRP-D015-18H11FS    SRP-D018-20C1FS    SRP-D018-20C2FS    • SRP-D018-20H1FS    SRP-D018-20H2FS    • SRP-D018-20H3FS  
O.D.: 20    O.D.: 24    O.D.: 24    O.D.: 24    O.D.: 29    O.D.: 29

**SPRAYER 24/410** Dosage 0.18 ml

**PUMP / LOTION 18/410** Dosage 0.15 ml



• SRP-D018-20H4FS    • SRP-D018-20H5FS    • SRP-D018-20H6FS    SRP-D018-24C1FS    SRP-D018-24C2FS    • SRP-D018-24H1FS    • SRP-D015-18C1FL1  
O.D.: 24    O.D.: 29    O.D.: 29    O.D.: 28    O.D.: 28    O.D.: 33    O.D.: 22



• SRP-D015-18C2FL1    • SRP-D015-18H1FL1    • SRP-D015-18H2FL1    • SRP-D015-18H3FL1    • SRP-D015-18C3FL1    • SRP-D015-18H11FL1    SRP-D015-18H12FL1  
O.D.: 22    O.D.: 22    O.D.: 22    O.D.: 22    O.D.: 20    O.D.: 20    O.D.: 20





**PUMP / LOTION**  
20/410 Dosage 0.18 ml



SRP-D015-18H12FL2 O.D.: 20  
SRP-D018-20C1FL2 O.D.: 24  
SRP-D018-20C2FL2 O.D.: 24  
SRP-D018-20H1FL2 O.D.: 24  
SRP-D018-20H2FL2 O.D.: 29  
SRP-D018-20H3FL2 O.D.: 29  
SRP-D018-20H4FL2 O.D.: 24

**PUMP / LOTION**  
24/410 Dosage 0.18 ml



SRP-D018-20H5FL2 O.D.: 29  
SRP-D018-20H6FL2 O.D.: 29  
SRP-D018-24C1FL2 O.D.: 28  
SRP-D018-24C2FL2 O.D.: 28  
SRP-D018-24H1FL2 O.D.: 33

**EXTERNAL SPRING**  
Dosage 0.2 ml



SRP-D020-18C1FS O.D.: 24  
SRP-D020-18C1FL1 O.D.: 24  
SRP-D020-20C1FS O.D.: 24  
SRP-D020-20C1FL1 O.D.: 24  
SRP-D020-24C1FS O.D.: 28  
SRP-D020-24C1FL1 O.D.: 28

**AIRLESS PUMP**  
20/410 Dosage 0.18 ml



SRP-A018-20H3FO O.D.: 24  
SRP-A018-20H3FL2 O.D.: 24  
SRP-A018-20H3FL1 O.D.: 24  
SRP-BT100-24C5F4 O.D.: 28

**HEAT AND COLD TEMPERATURE RESISTANT PUMP** Dosage 1 ml

**BACK SUCTION PUMP (EXTERNAL SPRING)**  
Dosage 1.0 ml



SRP-N100-24C5F1 O.D.: 28  
SRP-N100-24C2F1 O.D.: 28  
SRP-N100-24C5F2 O.D.: 28  
SRP-N100-24C2F2 O.D.: 28

**BACK SUCTION PUMP**

PATENT. 200920213472.X

Dosage 0.5 ml Dosage 0.7 ml



SRP-D050-24C1F21 O.D.: 28  
SRP-D070-24C85F31 O.D.: 29  
A SERIES O.D.: 28  
B SERIES O.D.: 28  
C SERIES O.D.: 28

▶ A		▶ B		▶ C	
Ref.	Dosage	Ref.	Dosage	Ref.	Dosage
SRP-D100-24C5F1	1.0 ml	SRP-D100-24C2F1	1.0 ml	SRP-D100-24C5F2	1.0 ml
SRP-D070-24C5F1	0.7 ml	SRP-D070-24C2F1	0.7 ml	SRP-D070-24C5F2	0.7 ml



D SERIES O.D.: 28  
E SERIES O.D.: 28  
F SERIES O.D.: 28  
G SERIES O.D.: 28

▶ D		▶ E		▶ F		▶ G	
Ref.	Dosage	Ref.	Dosage	Ref.	Dosage	Ref.	Dosage
SRP-D100-24C2F2	1.0 ml	SRP-D100-24H1F1	1.0 ml	SRP-D100-24H1F2	1.0 ml	SRP-D100-24C5F5	1.0 ml
SRP-D070-24C2F2	0.7 ml	SRP-D070-24H1F1	0.7 ml	SRP-D070-24H1F2	0.7 ml	SRP-D070-24C5F5	0.7 ml



ALUMINUM

► POLYLAMI

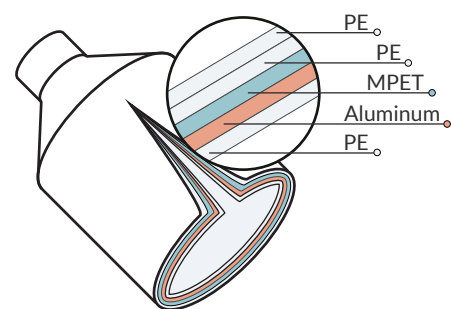

► SILVER ABL TUBE

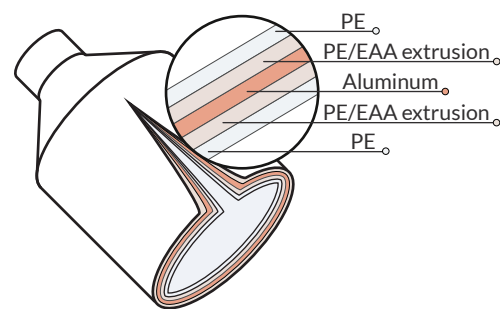

► WHITE ABL TUBE

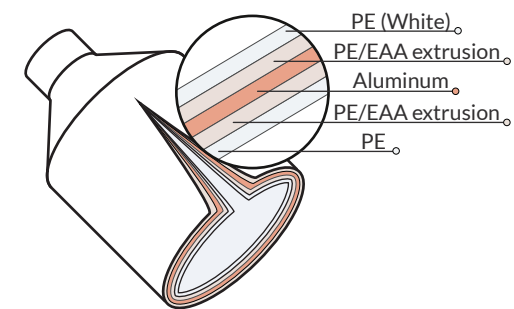

EXTRUDING MACHINE

► SINGLE LAYER TUBE

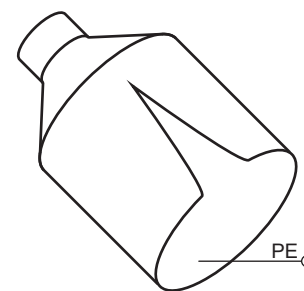

► 2 LAYER TUBE

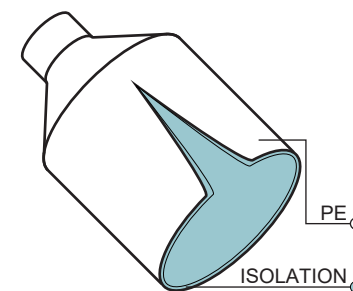

► 5 LAYER TUBE

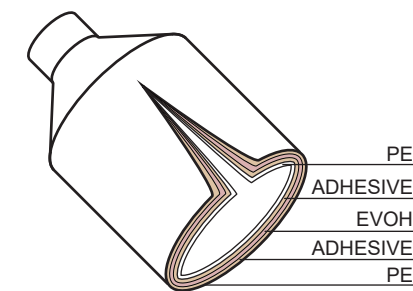

► TUBE DIAMETER & TUBE SHAPE COMPARATIVE TABLE

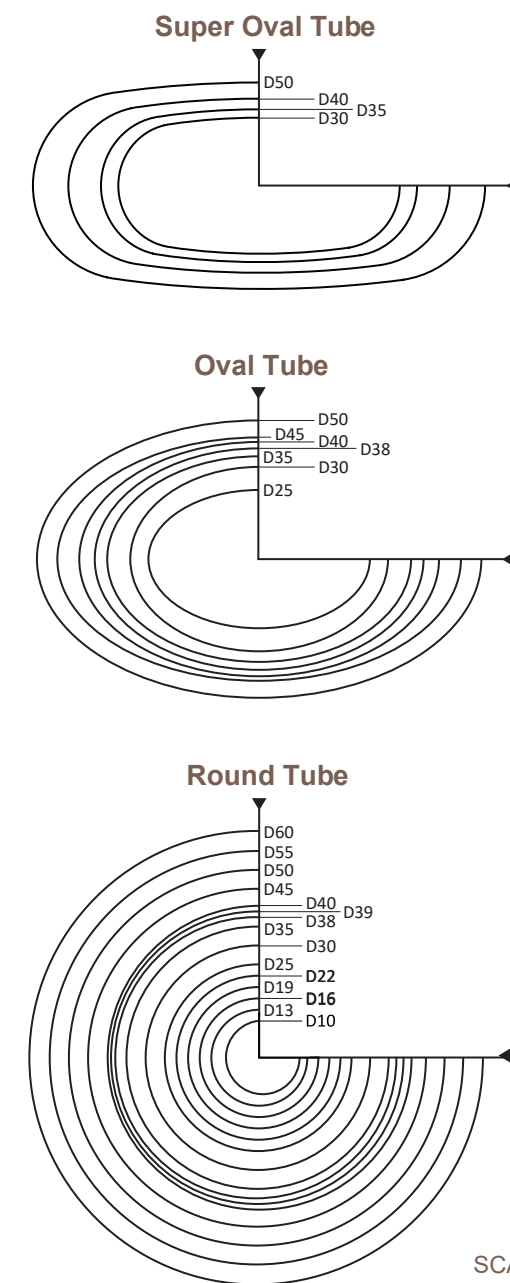

► TUBE CAPACITY TABLE

Φ	Capacity /ml	Length /mm	Φ	Capacity /ml	Length /mm	Φ	Capacity /ml	Length /mm
10	2	40	35	100	145	50	145	120
	3	60		110	150		150	123
	5	80		120	155		155	126
13	3	50		125	160		160	129
	5	60		130	165		165	132
	8	85		60	95		170	135
16	5	65	65	98	175		138	
	8	70	70	100	180		141	
	10	75	75	105	185		144	
	15	100	80	110	190		147	
19	10	55	85	115	195		150	
	15	80	90	120	200		153	
	20	95	95	125	210	159		
22	10	70	40	100	130	220	165	
	15	77	110	135	230	171		
	20	85	120	140	240	177		
	25	105	125	145	250	183		
	30	110	130	150	170	120		
25	20	70	135	155	175	123		
	25	80	140	160	180	126		
	30	90	145	165	185	129		
	35	100	150	170	190	133		
	40	110	55	100	105	195	137	
	45	120	110	115	200	140		
	50	130	120	125	210	147		
30	30	75	125	130	220	154		
	35	82	130	145	230	161		
	40	90	135	150	240	168		
	45	98	140	155	250	175		
	50	105	45	145	160	260	182	
	55	113	150	165	200	120		
	60	121	155	170	210	125		
35	65	129	160	175	220	130		
	70	137	165	180	230	135		
	50	95	170	185	240	140		
	55	100	175	190	250	145		
	60	105	180	195	260	150		
	65	110	100	95	270	155		
	70	115	110	100	280	160		
	75	120	120	105	290	165		
	80	125	50	125	108	300	185	
	85	130	130	111	400	200		
90	135	135	114					
95	140	140	117					

SCALE 1:1



Made-in-America tube supply

**Customize tubes made-in-America**

- ★ Works with all viscosity types.
- ★ Custom Color Matching.
- ★ Finish, glossy or matte.
- ★ Silkscreen printing, up to 3 colors.
- ★ Hot stamping.
- ★ Tamper evident seal: aluminium foil for orifice seal.

**Sponge applicator** | **Screw Head Tube** | Configurable components | **MIT** Made in Taiwan

**Cosmetic Applicator Tube**

**EC tube applicators**

EC tube applicators have two options for rod length and cap style.

**Nozzle Tube**



SC-14	SC-20-16	SC-20-19	SC-20-22	SC-20-25	DC-19-25	DC-10-19	DC-07-16	SC-14
						AVAILABLE FOR D19 / D22 / D25		
RT1320-ST ST-20 Φ13	MIT RT1620-ST ST-20 Φ16	RT1920-ST ST-20 Φ19	RT2220-ST ST-20 Φ22	MIT RT2520-ST ST-20 Φ25	RT3020-ST ST-20 Φ30			

| Common Style

FC-01	EC-55-30	23124350050	MIT MC-03-35	MC-04-35	MC-05-35	MC-01-35	23124350050
MIT RT3002-MT MT-02 Φ30	MIT SC-13	MIT RT3502-MT MT-02 Φ35	MIT FC-04-35	MIT FC-01-35	MIT SC-13		

MC-03-40	MIT FC-01-40	FC-04-40	23124350050	FC-01-40	FC-04-40	MC-03-40	OC-12
MIT RT4002-MT MT-02 Φ40	MC-01-40	SC-13	MIT RT5002-MT MT-02 Φ50	MC-01-40	SC-13	RT4019-MT MT-19 Φ40	

| Large Aperture Style

| Small Aperture Style

EC-18-40	FC-02-35	MC-02	D30	23141300002	MC-02-35	MC-19-19
RT4510-MT MT-10 Φ45	RT3518-MT MT-18 Φ35	RT3003-MT MT-03 Φ30	MC-19-19	RT3503-MT MT-03 Φ35	23141300002	

MC-02	EC-20-40	MC-19-19	23141190001 AVAILABLE FOR D30 / D35 / D40	SC-04-30	MC-07-30	MC-10-40
RT4003-MT MT-03 Φ40	MC-08	23141300002	RT3013-MT MT-13 Φ30	RT3017-MT MT-17 Φ30	RT4023-MT MT-23 Φ40	

| Nozzle Tube

| Roller Ball Style

SILICA GEL

| Common Style

SC-05-20	EC-24-19	EC-21-19	EC-21-35	23124400001	LC-02-45	MIT LC-01-45
RT3004-MT MT-04 Φ30	RT1929-01MT MT-29-01 Φ19	RT1928-MT MT-28 Φ19	RT3529-MT MT-29 Φ35	RT4038-MT MT-38 Φ40	MIT RT4501-LT LT-01 Φ45	FC-01-45



| Twist-lock Dispensing Tube

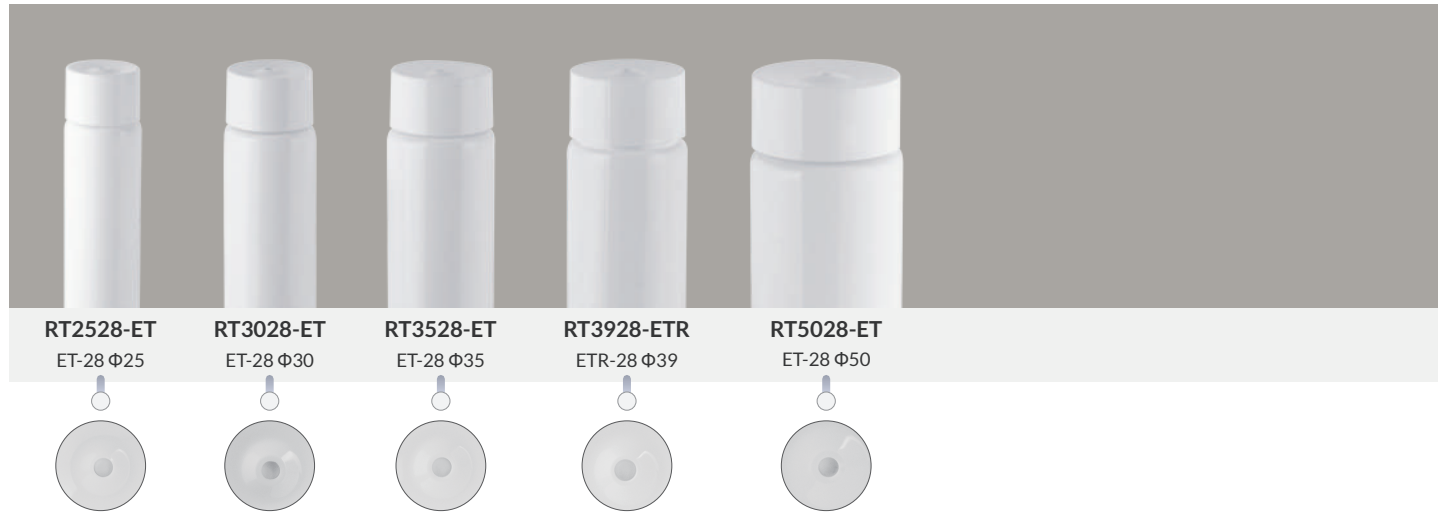

| Snap-off Tube

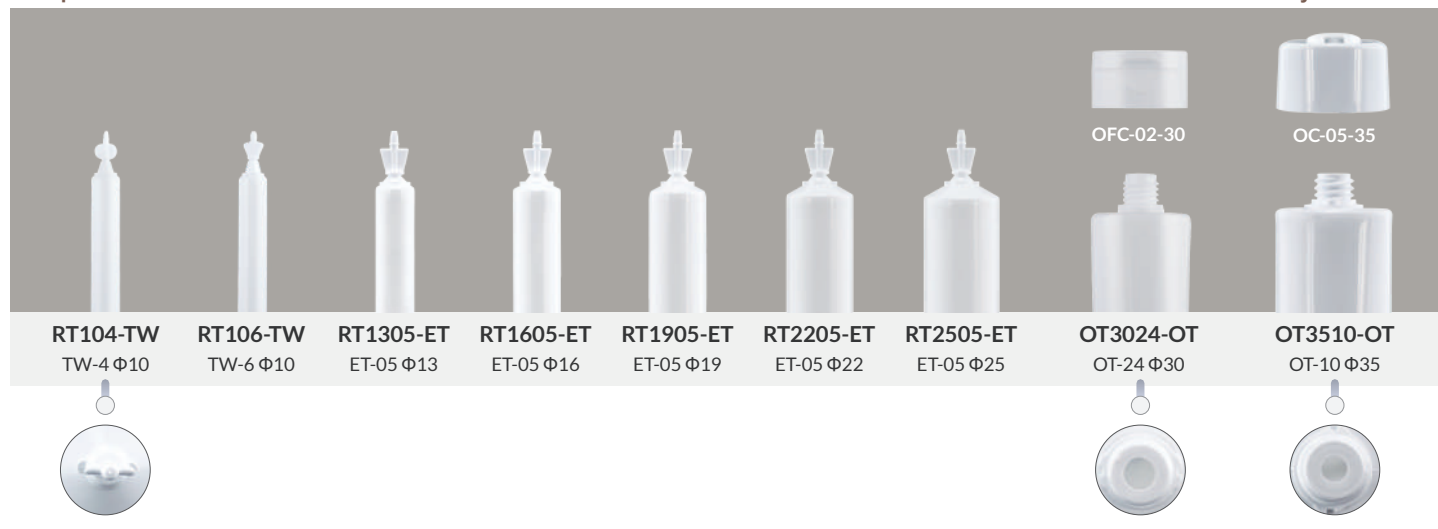

| Oval Tube : Common Style



| Oval Tube : Small Aperture Style



| Oval Tube : Nozzle Tube

DC-01-30		DC-06	OC-13-30	DC-02-22	OC-16-15	
	OT3533-OT OT-33 Φ35	OT2509-OT OT-09 Φ25	OT3013-OT OT-13 Φ30	OT2214-OT OT-14 Φ22	OT2514-OT OT-14 Φ25	

| Penta-shaped / Quadral

| Oval Tube : Dual Chamber Style

| Super Oval Tube : Small Aperture Style

OC-15-40	SC-14	OFC-04-45-01	OFC-03-45-01	OC-07	SOF-03-30	OC-08-30
OT4030-OT OT-30 Φ40	OT252901-OT OT-29-01 Φ25	OT4515-OT OT-15 Φ45	OT4520-OT OT-20 Φ45	OT351401-ET ET-14-01 Φ35	SOT3001-SOT SOT-01 Φ30	

SOFC-03-35	OC-08-35	SOFC-03-40	OC-08-40	OC-05-50	OC-08-50
SOT3502-SOT SOT-02 Φ35	SOT4003-SOT SOT-03 Φ40	SOT5004-SOT SOT-04 Φ50			SOFC-03-50

| Oval Tube

| Round Tube

| Round Tube

<p>Cover : SAN</p> <p><b>SRP-A020-15C1F1</b></p> <p>I.D.: 15/ O.D.: 36 (Cover) 15/410 - D30 Dosage 0.2 ml EOT-09-01</p>	<p>ET-ZL</p> <p><b>RT30ZL-ET</b></p> <p>D30, 35, 40mm Material: PP Dosage 0.25 ml LT-07</p>	<p>Dosage 0.25 ml</p> <p><b>RT3007-LT-166</b></p> <p>LT-07 Φ30</p>
---	---	--

| Round Tube

<p><b>RT2508-ET</b></p> <p>ET-08 Φ25</p>	<p><b>RT3008-ET</b></p> <p>ET-08 Φ30</p>	<p><b>RT3508-ET</b></p> <p>ET-08 Φ35</p>	<p><b>RT4008-ET</b></p> <p>ET-08 Φ40</p>
--	--	--	--

	Applicable	Dosage		Applicable	Dosage
	A-1	Φ25/Φ30/Φ35	0.25 ml	C-1	Φ25/Φ30/Φ35
MIT	A-2	Φ25/Φ30	0.2 ml	MIT C-2	Φ25/Φ30
	B	Φ25/Φ30/Φ35	0.25 ml	D	Φ30/Φ35/Φ40



**GA030**  
GA SERIES  
**GA050**  
GA SERIES  
**G-C050070**  
G-C SERIES  
**G-C050090**  
G-C SERIES



**G090-130A**  
G090 SERIES  
**G090-150A**  
G090 SERIES  
**G090-200A**  
G090 SERIES  
**G090-250A**  
G090 SERIES  
**G090-300A**  
G090 SERIES  
**G090-300B**  
G090 SERIES



**G50068**  
**GU-150B**  
GU/GUK SERIES  
**GU-200A**  
GU/GUK SERIES  
**GU-200C**  
GU/GUK SERIES  
**GUK-200**  
GU/GUK SERIES  
**G048-050**



**G050050A**  
G050 SERIES  
**G050080A**  
G050 SERIES  
**G050080B**  
G050 SERIES  
**G050080C**  
G050 SERIES  
**G067015**  
G067 SERIES  
**G067020**  
G067 SERIES  
**G067025**  
G067 SERIES

	Ref.	OFC (ml)	H. (mm)	L. / W. (mm)	Neck size	Wt
GA Series	GA030	58	39.5	Φ76.2	Φ70mm	21.5g
	GA050	78	39.5	Φ76.2	Φ70mm	21.5g
G-C Series	G-C050070	84	41.7	Φ61.9	Φ50mm	16g
	G-C050090	106	48.7	Φ63.86	Φ50mm	16g
G090 Series	G090-130A	208	37	Φ91.7	Φ90mm	27g
	G090-150A	220	39.5	Φ91.7	Φ90mm	27g
	G090-200A	270	47.1	Φ91.7	Φ90mm	27g
	G090-250A	320	54.9	Φ91.7	Φ90mm	30g
	G090-300A	370	62.5	Φ91.7	Φ90mm	30g
	G090-300B	370	69.8	Φ91.7	Φ90mm	30g
<b>G50068</b>	84	43.9	Φ59	Φ50mm	16g	

	Ref.	OFC (ml)	H. (mm)	L. / W. (mm)	Neck size	Wt
GU / GUK Series	GU-150B	188	57.9	Φ73	Φ70mm	21g
	GU-200A	238	50	Φ85.4	Φ70mm	21g
	GU-200C	239	50	Φ90	Φ70mm	21g
	GUK-200	239	47.7	Φ90	Φ70mm	21g
G050 Series	<b>G048-050</b>	65	41.5	Φ50.1	Φ48mm	14g
	G050050A	69	36	Φ59	Φ50mm	16g
	G050080A	100	43	Φ63.5	Φ50mm	16g
	G050080B	100	43	68x59	Φ50mm	16g
	G050080C	100	43	59.7x59.7	Φ50mm	16g
	G067015	185	52.5	Φ73	Φ67.5mm	22g
	G067020	240	66.5	Φ73	Φ67.5mm	22g
G067025	295	79.5	Φ73	Φ67.5mm	22g	



**G070010**  
G070 SERIES  
**G070015**  
G070 SERIES  
**G070020**  
G070 SERIES  
**G070025**  
G070 SERIES  
**G106050**  
G106 SERIES  
**G106090**  
G106 SERIES



**SRJ-S070-120**  
**SRJ-S089-200B**  
PETG Material / SAN Material  
**SRJ-S089-300**  
SAN Material  
**SRJ-S089-350B**  
PETG Material / SAN Material  
**GZ-050-010**  
ABS Material  
**SRJ-VS048-025**  
AL Material

MIT Made in Taiwan



**SRJ-089-400**  
PP Material  
**DSG-35A**  
PP Material  
**G057050**  
PP Material  
**GZ-EC-22**  
PP Material  
**PP250**  
PP Material

	Ref.	OFC (ml)	H. (mm)	L. / W. (mm)	Neck size	Wt
G070 Series	G070010	139	39.7	Φ73	Φ70 mm	21g
	G070015	189	51.7	Φ73	Φ70 mm	21g
	G070020	239	63.7	Φ73	Φ70 mm	21g
	G070025	289	76	Φ73	Φ70 mm	21g
	G106 Series	G106050	650	76	Φ110.5	Φ106 mm
G106090		1050	115	Φ111.5	Φ106 mm	58g
SAN Material	<b>SRJ-S070-120</b>	146	44.2 (Cap)	Φ73	70/400	21g
	SRJ-S089-200B4	230	46	Φ90.1	Φ88.6 mm	56.7g
	<b>SRJ-S089-200B3</b>	235	49	Φ90.1	Φ88.6 mm	75.2g
	SRJ-S089-300	329	64.5	Φ92.3	Φ89 mm	82.5g
	SRJ-S089-350B5	380	75	Φ90.1	Φ88.6 mm	92g
	<b>SRJ-S089-350B2</b>	375	75	Φ90.1	Φ88.6 mm	111.7g

SRJ-S089-200B3 & SRJ-S089-350B2 ARE THICK WALL STYLE

	Ref.	OFC (ml)	H. (mm)	L. / W. (mm)	Neck size	Wt
PETG Material	SRJ-S089-200B4	230	46	Φ90.1	Φ88.6mm	68.5g
	SRJ-S089-350B5	380	75	Φ90.1	Φ88.6mm	110g
ABS	GZ-050-010	10	21.1	Φ50.5	Φ50mm	17.3g
AL	SRJ-VS048-025	28	16.5	Φ48.4	Φ48mm	4.6g
PP Material	SRJ-089-400 MIT	443	70.1 (Cap)	Φ103	Φ89mm	31g
	DSG-35A	43.7	41.2	Φ55	Φ51.8mm	17g
	G057050	76.5	35	Φ59.7	Φ57mm	11.5g
	GZ-EC-22	83	28.7	Φ73	Φ70mm	17g
	PP250	295	42.7	Φ103.6	Φ103mm	26.6g



**KJ-200C**  
KJ-C SERIES

**KJ-300C**  
KJ-C SERIES

**KJ-450C**  
KJ-C SERIES

**KJ-600C**  
KJ-C SERIES



**KJ-150DS**  
KJ-DS SERIES

**KJ-200DS**  
KJ-DS SERIES

**KJ-350DS**  
KJ-DS SERIES

**KJ-500DS**  
KJ-DS SERIES



**KJ-150H**  
KJ-H SERIES

**KJ-200H**  
KJ-H SERIES

**KJ-350H**  
KJ-H SERIES

**KJ-500H**  
KJ-H SERIES



**KS-200A**  
KS-A SERIES

**KS-350A**  
KS-A SERIES

**KS-500A**  
KS-A SERIES

**KS-200B**  
KS-B SERIES

**KS-350B**  
KS-B SERIES

**KS-500B**  
KS-B SERIES



**KS-150C**  
KS-C SERIES

**KS-200C**  
KS-C SERIES

**KS-400C**  
KS-C SERIES

**KS-150D**  
KS-D SERIES

**KS-200D**  
KS-D SERIES

**KS-350D**  
KS-D SERIES

**KS-500D**  
KS-D SERIES

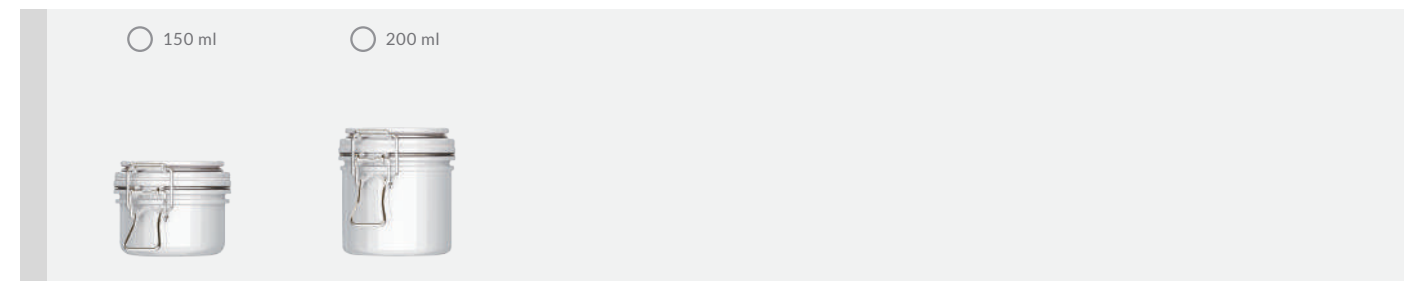

**KS-150DS**  
KS-DS SERIES

**KS-200DS**  
KS-DS SERIES

**KJ-(A)**  
Easy-Leakproof Screwable  
Kilner Jar



**KJ-(B)**  
Uni-leakproof Screwable  
Kilner Jar



	Ref.	OFC (ml)	H. (mm)	L. / W. (mm)	Neck size	Wt
<b>KJ-C Series</b>	KJ-200C	297	62.9	Φ79.5	Φ73mm	46g
	KJ-300C	369	78.8	Φ79.5	Φ73mm	46g
	KJ-450C	565	78.9	Φ98	Φ93mm	65g
	KJ-600C	715	95.7	Φ98	Φ93mm	65g
	KJ-150DS	213	60.1	Φ79	Φ73mm	46g
<b>KJ-DS Series</b>	KJ-200DS	264	72.5	Φ79	Φ73mm	46g
	KJ-350DS	454	80.5	Φ95.9	Φ93mm	65g
	KJ-500DS	593	102.4	Φ95.8	Φ93mm	65g
	KJ-150H	228	55.3	Φ84	Φ73mm	46g
<b>KJ-H Series</b>	KJ-200H	278	62.7	Φ86	Φ73mm	46g
	KJ-350H	464	72.8	Φ100	Φ93mm	65g
	KJ-500H	614	88.3	Φ103	Φ93mm	65g

	Ref.	OFC (ml)	H. (mm)	L. / W. (mm)	Neck size	Wt
<b>KS-A Series</b>	KS-200A	250	65.4	78x78	Φ76mm	46g
	KS-350A	441	75.5	93.5x93.5	Φ93mm	72g
	KS-500A	590	80.5	100x100	Φ93mm	72g
<b>KS-B Series</b>	KS-200B	250	79	Φ78	Φ76mm	46g
	KS-350B	447	91.8	Φ93.5	Φ93mm	72g
	KS-500B	591	118.5	Φ93.5	Φ93mm	72g
<b>KS-C Series</b>	KS-150C	209	52.9	78x78	Φ76mm	46g
	KS-200C	257	62.5	78x78	Φ76mm	46g
	KS-400C	509	78.5	94x94	Φ93mm	72g

	Ref.	OFC (ml)	H. (mm)	L. / W. (mm)	Neck size	Wt
<b>KS-D Series</b>	KS-150D	157	50.3	Φ78	Φ76mm	46g
	KS-200D	252	71.5	Φ78	Φ76mm	46g
	KS-350D	441	79.7	Φ93.5	Φ93mm	72g
	KS-500D	591	104.1	Φ93.5	Φ93mm	72g
<b>KS-DS Series</b>	KS-150DS	158	50.3	Φ78	Φ76mm	46g
	KS-200DS	258	71.5	Φ78	Φ76mm	46g

**Kilner Jar Spec Guide**

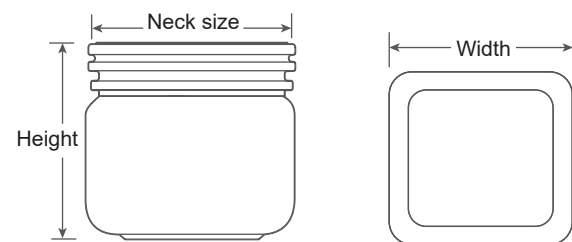

**Inner Plug for Kilner Jar**



LDPE inner plug  
Extends product shelf life  
Fits Dia. 76 Kilner Jar

R&D center, production base of EBM Airless

**Taiwan** | HQ & factory | SR Packaging Inc.

+886 4 2531 6216  
No. 550, Sishih Rd.  
Fengyuan Dist. Taichung 42077  
sales@srpackaging.com

One-stop production from molding to decoration

**China** | factory | Shanghai SR Packaging  
Technology Co., Ltd.

+86 21 5757 7631  
Building 2, No. 585 Pinglin Rd.  
Zhelin Town, Fengxian District  
Shanghai 201416

Made-in-America tube & PET bottle supply

**USA** | factory | SR Packaging  
North America Inc.

+1 610-778-0038  
6670 Grant Way  
Allentown  
PA 18106

